

DOORDESIGNS

FINISHED DOOR THICKNESS 13/16"

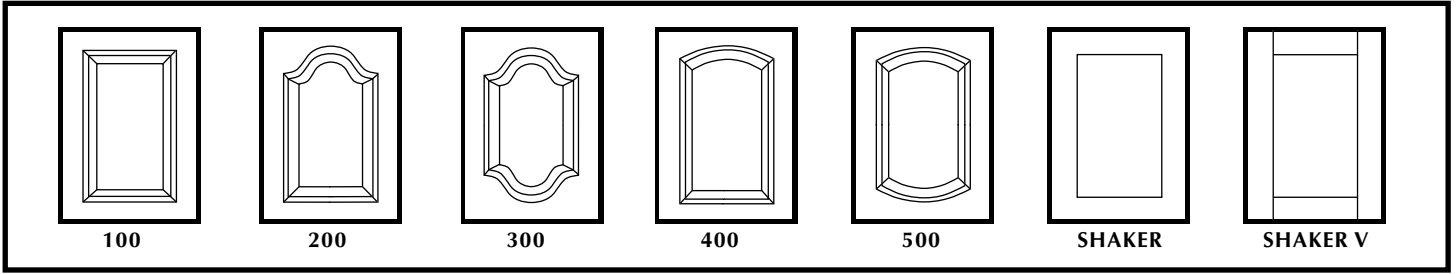

STILE/RAILPROFILES

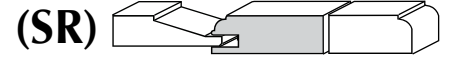

R REGULAR

13/16" SR1 2 1/4" ☆ 13/16" SR3 2 1/4" ☆ (1/4" BEVEL) 13/16" SR9 2 1/4" 13/16" SR19 2 1/4" (1/8" BEVEL) 3/8"

13/16" SR13 2 1/4" 13/16" SR2 2 1/4" ☆ 13/16" SR7 2 1/4" ☆ (1/8" BEVEL) 13/16" SR11 2 1/4" ☆ 13/16" SR20 2 1/4" 3/8"

W WIDE

13/16" SR15 2 3/4" 13/16" SR18 2 3/4" 3/8" 13/16" SR16 2 3/4" 3/8"

13/16" SR4 3" ☆ 13/16" SR12 3" ☆ 13/16" SR6 3" ☆ (1/4" BEVEL)

13/16" SR8 3" ☆ (1/8" BEVEL) 13/16" SR5 3" ☆ 13/16" SR14 3"

P PREMIUM

13/16" SR10 3 1/2" 7/8" SR17 3 3/8"

NOTE: Knotty Pine is only available in SR1 to SR8.

NOTE: (☆) indicates profiles available in MDF and Birch.

NOTE: SR16, SR18, SR19, SR20 only available with panel P10 (3/8" Panel) in Oak, Maple & Cherry.

EDGEPROFILES

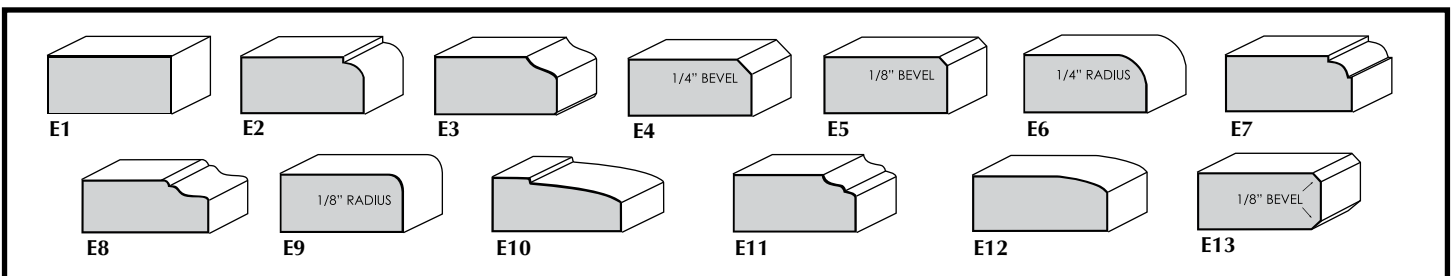

NOTE: Drawer fronts are available as 5-piece or as a slab (edge profiles match the door); horizontal grain direction is standard.

NOTE: On 5pc Mortise & Tenon drawer fronts with edge profiles E8, E10, and E12 edge profiles are reduced by approximately 5 mm.

PANEL PROFILES

Profiles with solid grey are solid wood panels

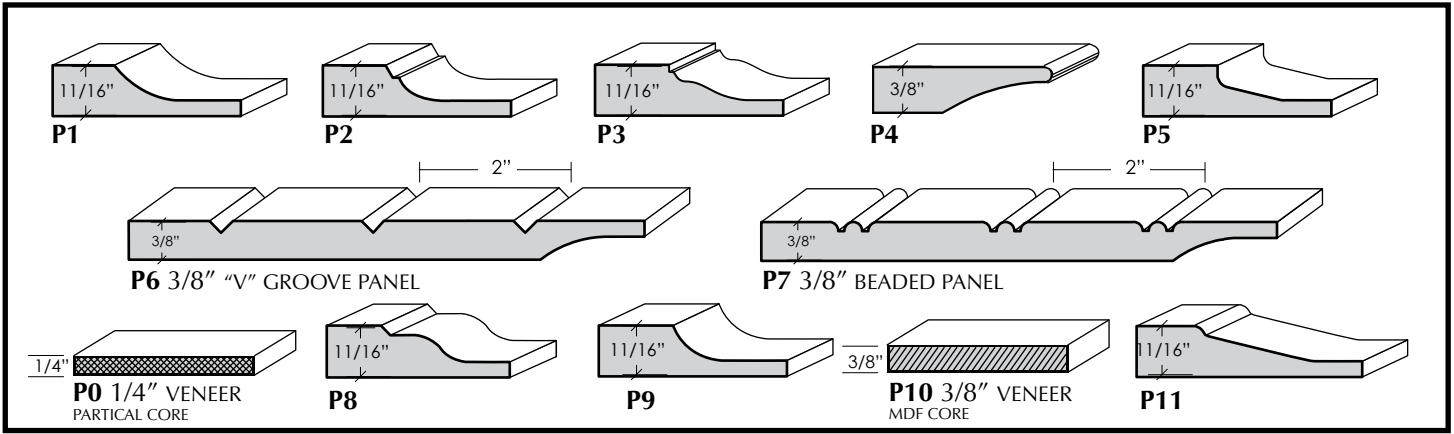
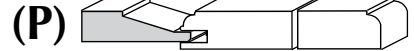

NOTE: All panel profiles available in raw MDF with exception of P10.

NOTE: P4, P6 & P7 are reversed solid panels.

APPLIED MOULDINGS

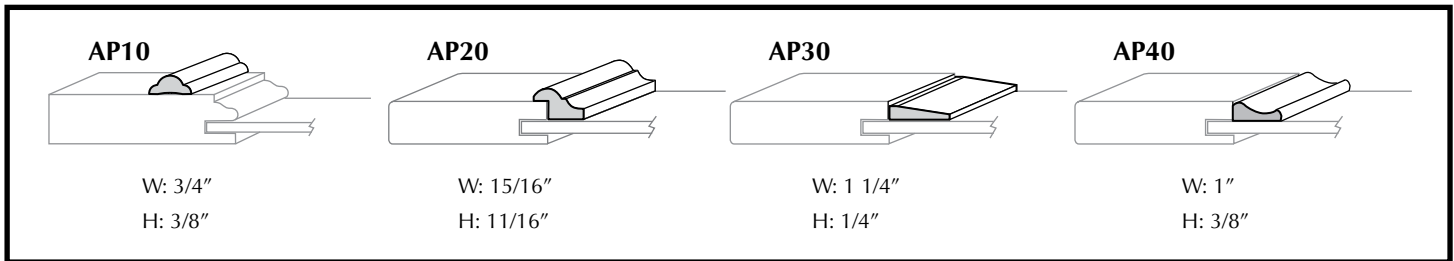

NOTE: The AP10 can be applied to all Mortise & Tenon rails with exception to SR3, SR6, SR7, SR8, SR16, and SR19.

NOTE: The AP20, AP30 & AP40 are only available on SR2 & SR5. the AP30 is also available on the SR3, SR6, SR7, and SR8.

NOTE: Doors over 48\"/>

GLASS DOORS

MORTISE & TENON FRAME ONLY & MULLION DOORS

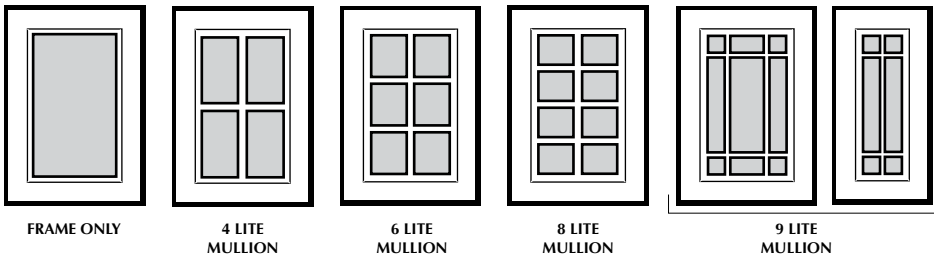

Glass doors selected with 9 lite mullions are only available over 14 3/4\"/>

MITRED DOORS

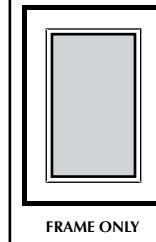

NOTE: Mitred rail M1 & M2 are also available in 4 lite, 6 lite, and 8 lite mullion doors as well as frame only. All other mitred doors are available as frame only.

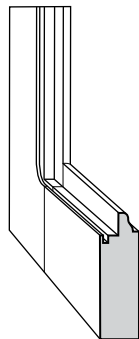

Doors Machined for Glass...

Mortise & Tenon Wood Doors are available in all 5 glass doors styles. The frame is machined to accept up to a 3mm to 6mm glass panel.

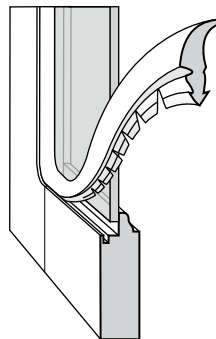

Glass Door Retainer Gasket...

All glass doors are machined with a channel to accept a rubber gasket. This gasket gives a firm clean fit to the door and glass panel.

Available through:
Richelieu Hardware
PART # 100 1711
 1-800-387-9505
 www.richelieu.com